

CNC

MOBILE AND INDUSTRIAL HYDRAULIC

www.cnc-world.com

CNC30 A SERİSİ **CNC30 A SERIE**



MALZEME ÖZELLİKLERİ

MATERIAL FEATURES

PA6 %30 Cam Elyaf
PA6 With %30 Fiber Glass

HIZ

SPEED

7 m/sn
7 m/sec

ÇALIŞMA SICAKLIĞI

OPERATING TEMPERATURE

-30°C ~ + 130°C

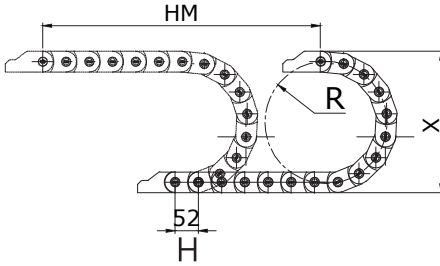
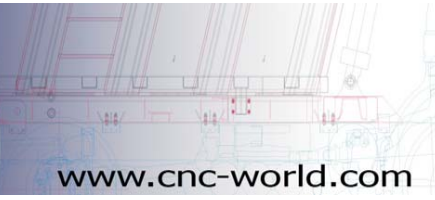

L Kullanılacak Miktar
Calculation of the Chain Length

HM Hareket Mesafesi
Movement Distance

X Montaj Yüksekliği
Mounting Height

Y Radyüs Mesafesi
Radius Distance

H Hatve
Pitch

$$L = HM / 2 + Y$$

$$X = R \times 2 + C$$

$$Y = R \times \pi$$

Kıvrılma Yarıçapı / Bending Radius	50	75	100	150
H (mm)	52	52	52	52
X (mm)	147	197	247	347
Y (mm)	157	236	314	471

YÜK DİYAGRAMI LOAD DIAGRAM

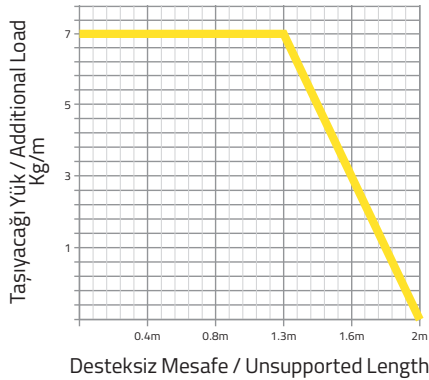



www.cnc-world.com

CNC
MOBILE AND INDUSTRIAL HYDRAULIC

CNC30 A SERİSİ

CNC30 A SERIE

İçten ve Dıştan Açılabilir Seri
Openable From Inner and Outside

Örnek Ürün Kodu
Product No. Example

CNC30

İç Yükseklik
Inner Height

A

Açık Seri
Open Serie

060

İç Genişlik
Inner Width

R100

Kıvrılma Yarıçapı
Bending Radius

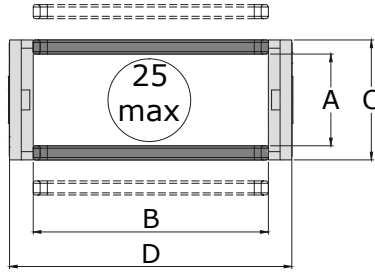

CNC30 A	A	B	C	D	R	W
MODEL	İç Yükseklik (mm) Inner Height (mm)	İç Genişlik (mm) Inner Width (mm)	Dış Yükseklik (mm) Outer Height (mm)	Dış Genişlik (mm) Outer Width (mm)	Kıvrılma Yarıçapı Bending Radius	Ağırlık Kg/Mt Weight Kg/Mt
CNC30 A 040 R ...	30	40	47	62	50, 75, 100, 150	1,152
CNC30 A 050 R ...		50		72		1,190
CNC30A 060 R ...		60		82		1,228
CNC30 A 080 R ...		80		102		1,304
CNC30 A 100 R ...		100		122		1,380





Plastik Dikey Seperatör Ölçüleri

Plastic Vertical Seperator Dimensions

CNC30 SP

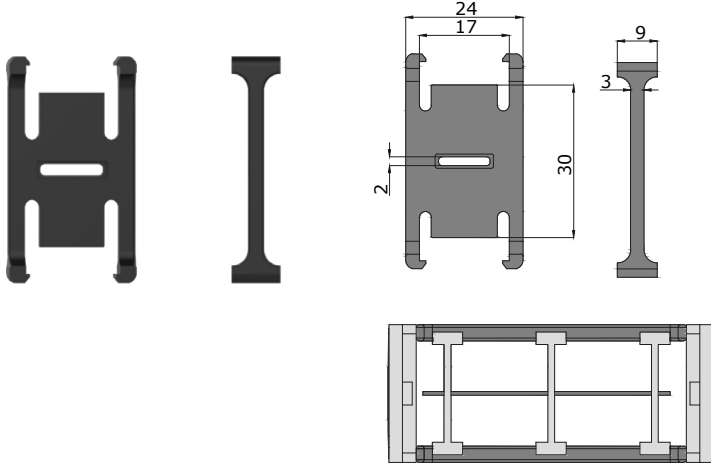

Plastik Yatay Seperatör Ölçüleri

Plastic Horizontal Seperator Dimensions

CNC30YSP

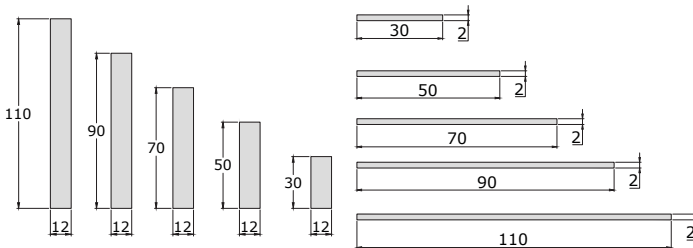



www.cnc-world.com

CNC
MOBILE AND INDUSTRIAL HYDRAULIC

Plastik Ayak Montaj Ölçüleri

Plastic End Bracket Assembly Dimensions

CNC30 P

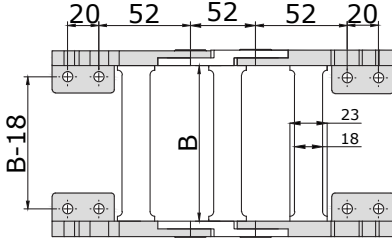

'B' ölçüsünü ölçü tablosundan bulabilirsiniz.
You will find the 'B' dimension from model table.

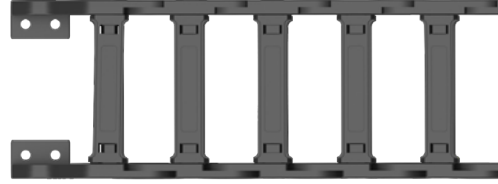

Plastik Ayak Bağlantı Şekilleri

Plastic End Bracket Assembly

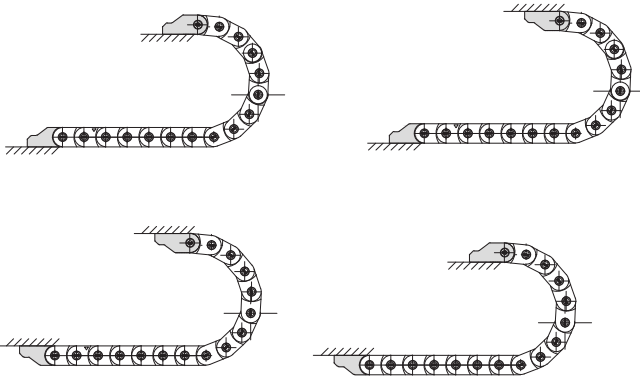



www.cnc-world.com



Metal Ayak Montaj Ölçüleri

Steel End Bracket Assembly Dimensions

CNC30 M

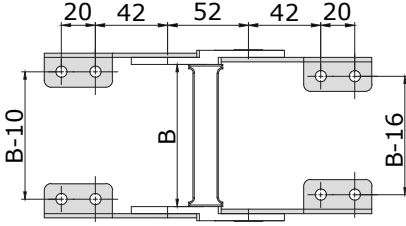

'B' ölçüsünü ölçü tablosundan bulabilirsiniz.
You will find the 'B' dimension from model table.

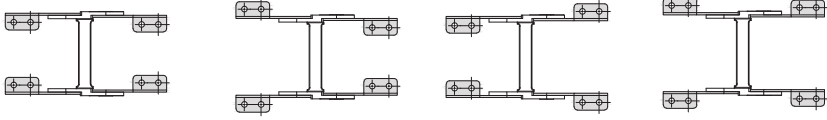

Metal Ayak Bağlantı Şekilleri

Steel End Bracket Assembly

